

Entering the era of mega-genomics

Michael Schatz

March 13, 2012
iPlant Tech Talk



Schatz Lab Overview



Computation

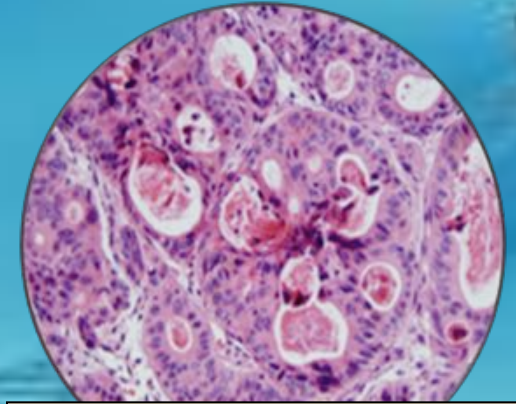

Human Genetics



Sequencing

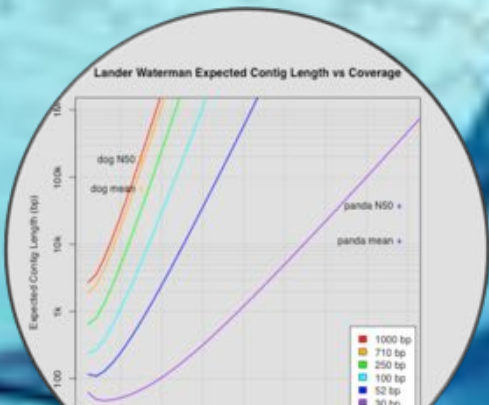

Modeling

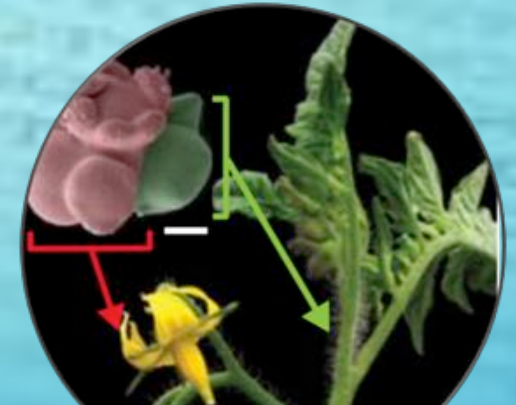

Plant Genomics

Outline



1. Milestones in genomics
 1. Sanger to nanopore
 2. 21st Century Mega-Genomics

2. Applications of mega-genomics
 1. Single molecule sequencing & assembly
 2. Cloud-scale resequencing
 3. De novo mutations in autism

Advances in Sequencing: Zeroth, First, Second Generation

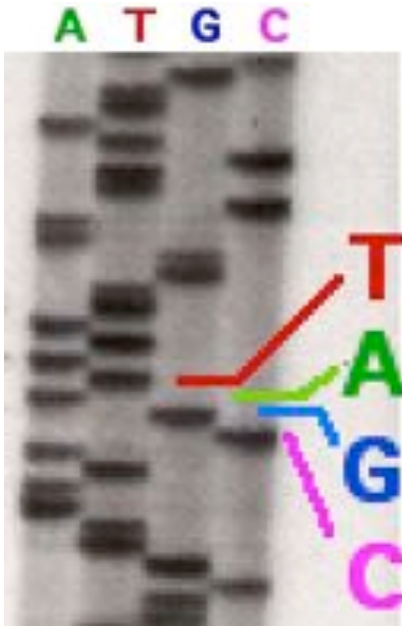

1970s: 0th Gen

Radioactive Chain
Termination

5000bp / week



1980s-1990s: 1st Gen

Automated Capillary
Sequencing

384kbp / day



2000s: 2nd Gen

Pyrosequencing, SOLiD
Sequencing-by-Synthesis

1Gbp / day

Advances in Sequencing: Now Generation Sequencing



Illumina HiSeq 2000
Sequencing by Synthesis

>60Gbp / day



Ion Proton
Postlight Sequencing

>100Gbp / day



Oxford Nanopore
Nanopore sensing

Many GB / day

Sequencing Centers



Next Generation Genomics: World Map of High-throughput Sequencers
<http://pathogenomics.bham.ac.uk/hts/>

The rise of mega-genomics

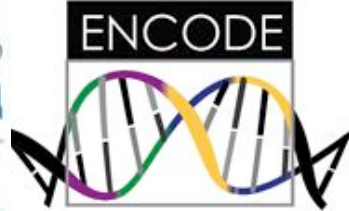

De novo Assembly

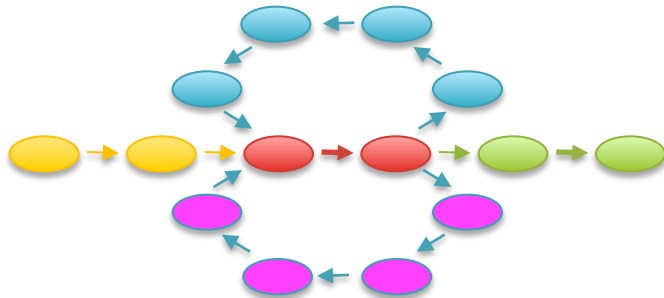

Alignment & Variations

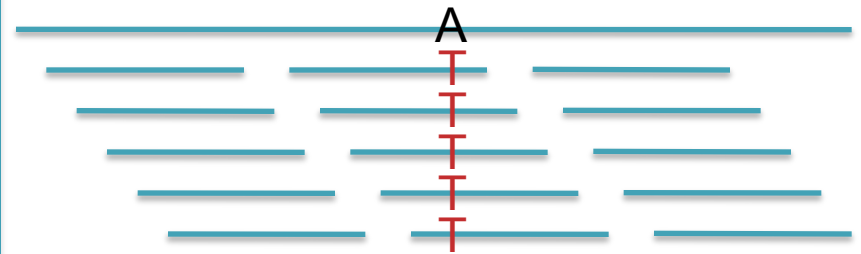

Differential Analysis

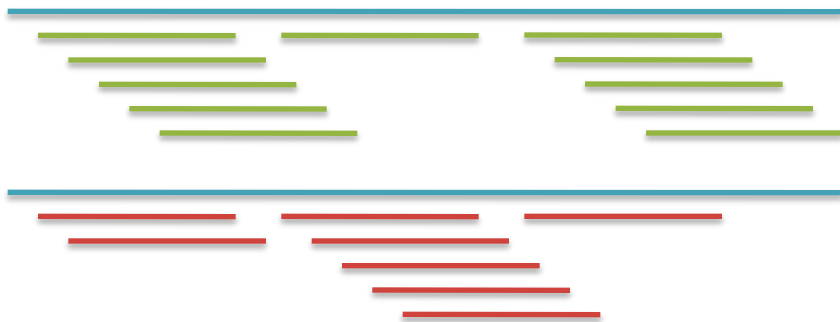

Phylogeny, Evolution, and Modeling

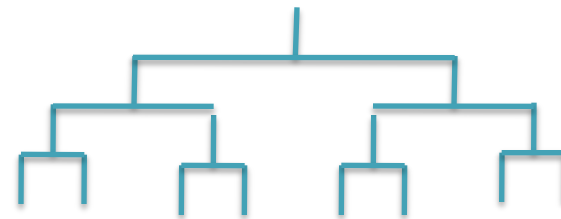

Mega-Genomics Challenges



The foundations of genomics will continue to be *observation, experimentation, and interpretation*

- Technology will continue to push the frontier
- Measurements will be made *digitally* over large populations, at extremely high resolution, and for diverse applications

Rise in Quantitative Demands

1. *Experimental design*: selection, collection & metadata
2. *Observation*: measurement, storage, transfer, computation
3. *Integration*: multiple samples, assays, analyses
4. *Discovery*: visualizing, interpreting, modeling

The rise of mega-genomics

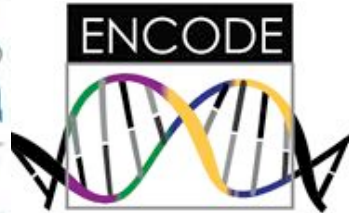

De novo Assembly

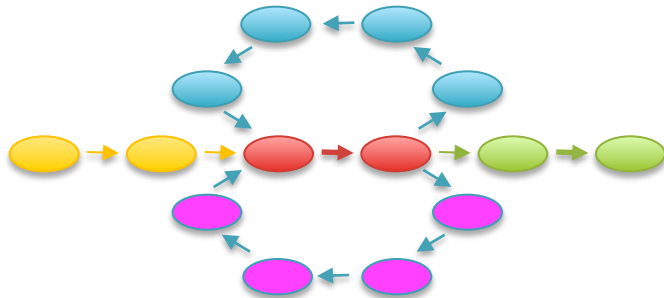

Alignment & Variations

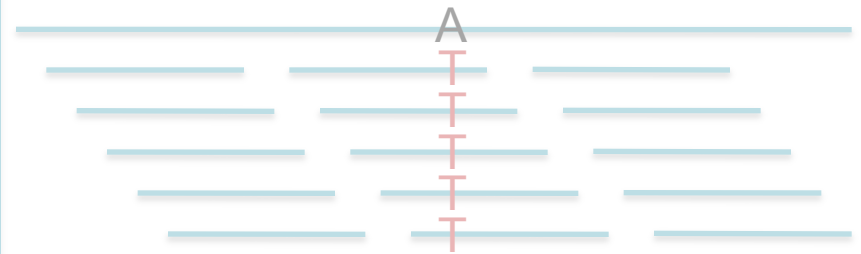

Differential Analysis



Phylogeny, Evolution, and Modeling

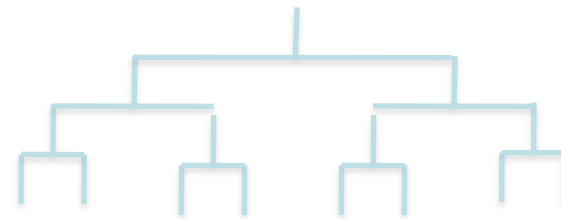

Assembling a Genome

1. Shear & Sequence DNA

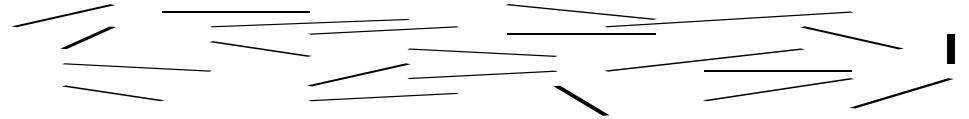

2. Construct assembly graph from overlapping reads

...AGCCTAGACCTACAGGATGCGCGACACGT
GGATGCGCGACACGTTCGCATATCCGGT...

3. Simplify assembly graph

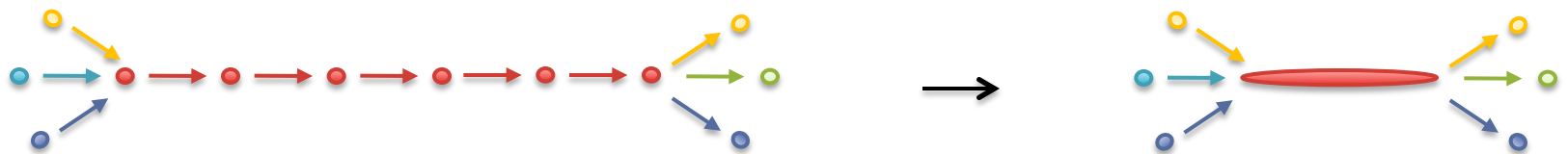

4. Detangle graph with long reads, mates, and other links

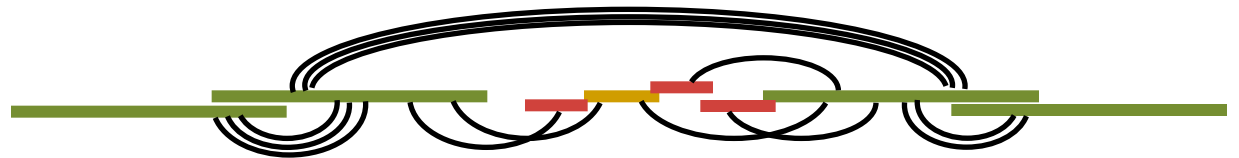

Ingredients for a good assembly

Coverage

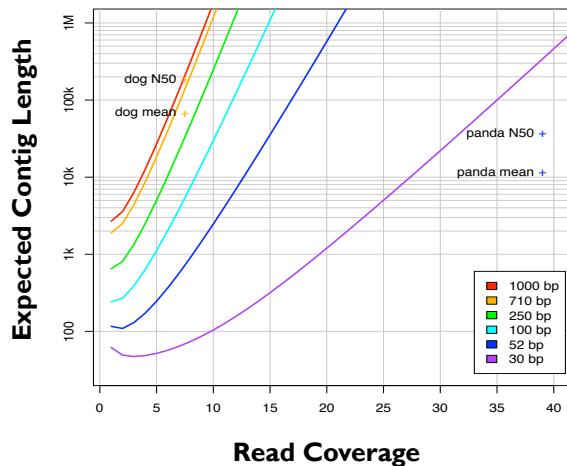

High coverage is required

- Oversample the genome to ensure every base is sequenced with long overlaps between reads
- Biased coverage will also fragment assembly

Read Length

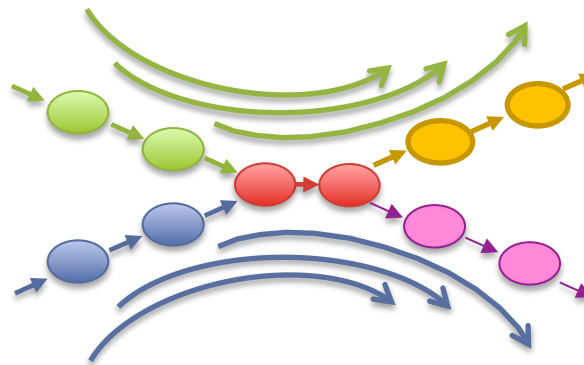

Reads & mates must be longer than the repeats

- Short reads will have **false overlaps** forming hairball assembly graphs
- With long enough reads, assemble entire chromosomes into contigs

Quality

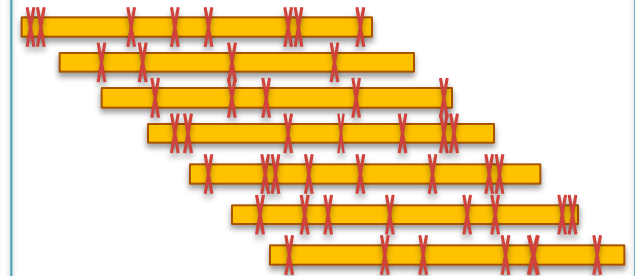

Errors obscure overlaps

- Reads are assembled by finding kmers shared in pair of reads
- High error rate requires very short seeds, increasing complexity and forming assembly hairballs

Assembly of Large Genomes using Second Generation Sequencing

Schatz MC, Delcher AL, Salzberg SL (2010) *Genome Research*. 20:1165-1173.

Hybrid Sequencing



Illumina

Sequencing by Synthesis

High throughput (60Gbp/day)

High accuracy (~99%)

Short reads (~100bp)



Pacific Biosciences

SMRT Sequencing

Lower throughput (600Mbp/day)

Lower accuracy (~85%)

Long reads (1-2kbp+)

SMRT Sequencing Data

Yeast (12 Mbp genome)

65 SMRT cells
734,151 reads after filtering
Mean: 642.3 +/- 587.3
Median: 553 Max: 8,495

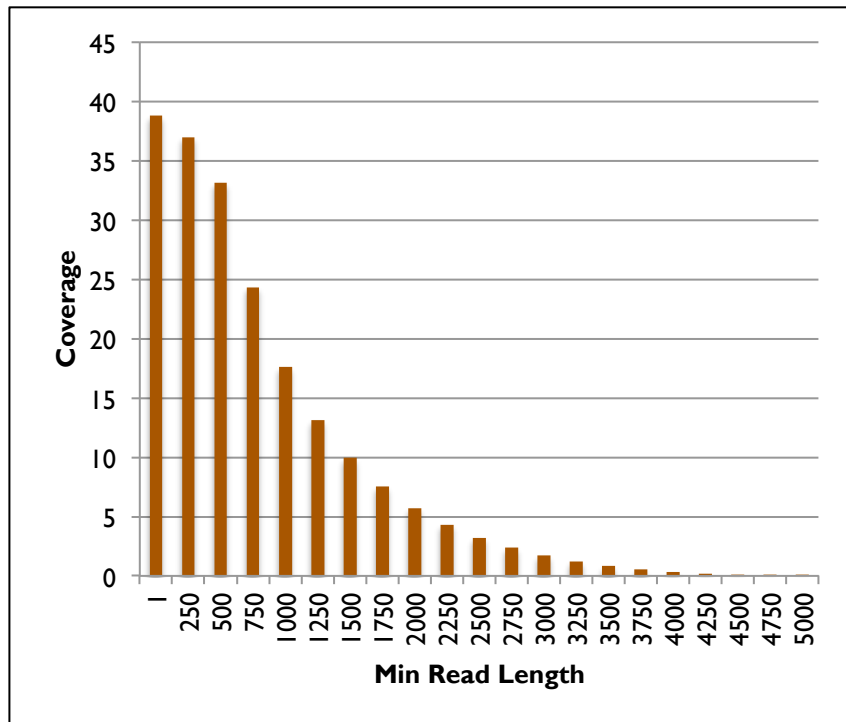

TTGTAAGCAGTTGAAAACCTATGTGTGGATTAGATAAAGAACATGAAAG
TTGTAAGCAGTTGAAAACCTATGTGTGATTAGATAAAGAACATGAAAG

ATTATAAAGCAGTTGATCCATTAGAAGAAAGAACGCAAAGGCGCTAGG
A-TATAAATCAGTTGATCCATTAAAGAAAGAAACGC-AAAGGC-GCTAGG

C AACCTTGAATGTAATCGCACTTGAAGAACAAGATTTTATTCCGCGCCCG
C-ACCTTGATGTAT--CACTTGAAGAACAAGATTTTATTCCGCGCCCG

T AACGAATC AAGATTCTGAAAACACATATAACAACCTCCAAAAACACAA
T-ACGAATC-AGATTCTGAAAACAATGAT-----ACCTCCAAAAACACAA

-AGGAGGGGAAAAGGGGGGAATATCTATAAAAAGATTACAAATTAGATGA
GAGGAGG---AA-----GAATATCTGAT-AAAGATTACAAATT-GAGTGA

ACTAATTCACAATAATAACACTTTTAAACAGAATTGATGGAA-GTT
ACTA AATTCACAAATAATAACACTTTTAAAGACA AATTGATGGGAAGGTT

TCGGAGAGATCCAAAACAATGGGCATCGCCTTTGA-GTTAC-AATCAAA
TC-GAGAGATCC-AAACAAT-GGCATCG-CCTTTGACGTTACA AATCAAA

ATCCAGTGAAAAATATAATTTATGCAATCCAGGAACCTTATTCACAATTAG
ATCCAGT-GAAAAATATA--TTATGCATCCA-GAACCTTATTCACAATTAG

Sample of 100k reads aligned with BLASR requiring >100bp alignment
Average overall accuracy: 83.7%, 11.5% insertions, 3.4% deletions, 1.4% mismatch

PacBio Error Correction

<http://wgs-assembler.sf.net>



I. Correction Pipeline

1. Map short reads (SR) to long reads (LR)
2. Trim LRs at coverage gaps
3. Compute consensus for each LR

2. Error corrected reads can be easily assembled, aligned

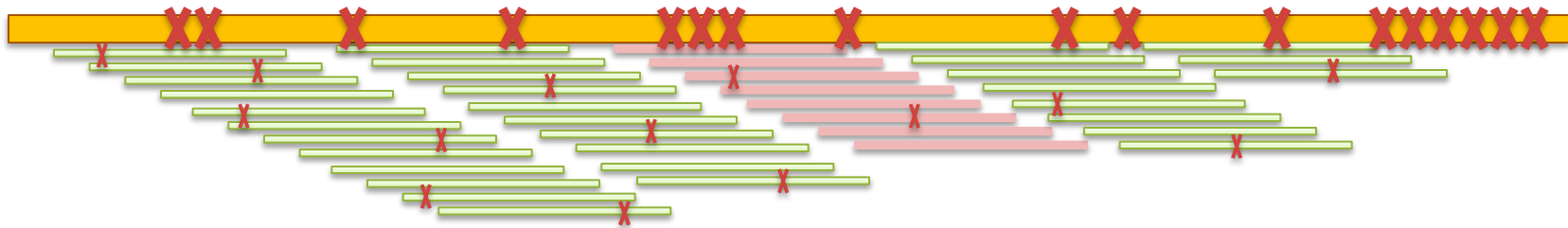

Hybrid error correction and de novo assembly of single-molecule sequencing reads.

Koren, S, Schatz, MC, Walenz, BP, Martin, J, Howard, J, Ganapathy, G, Wang, Z, Rasko, DA, McCombie, WR, Jarvis, ED, Phillippy, AM. (2012) *Under Review*

Error Correction Results

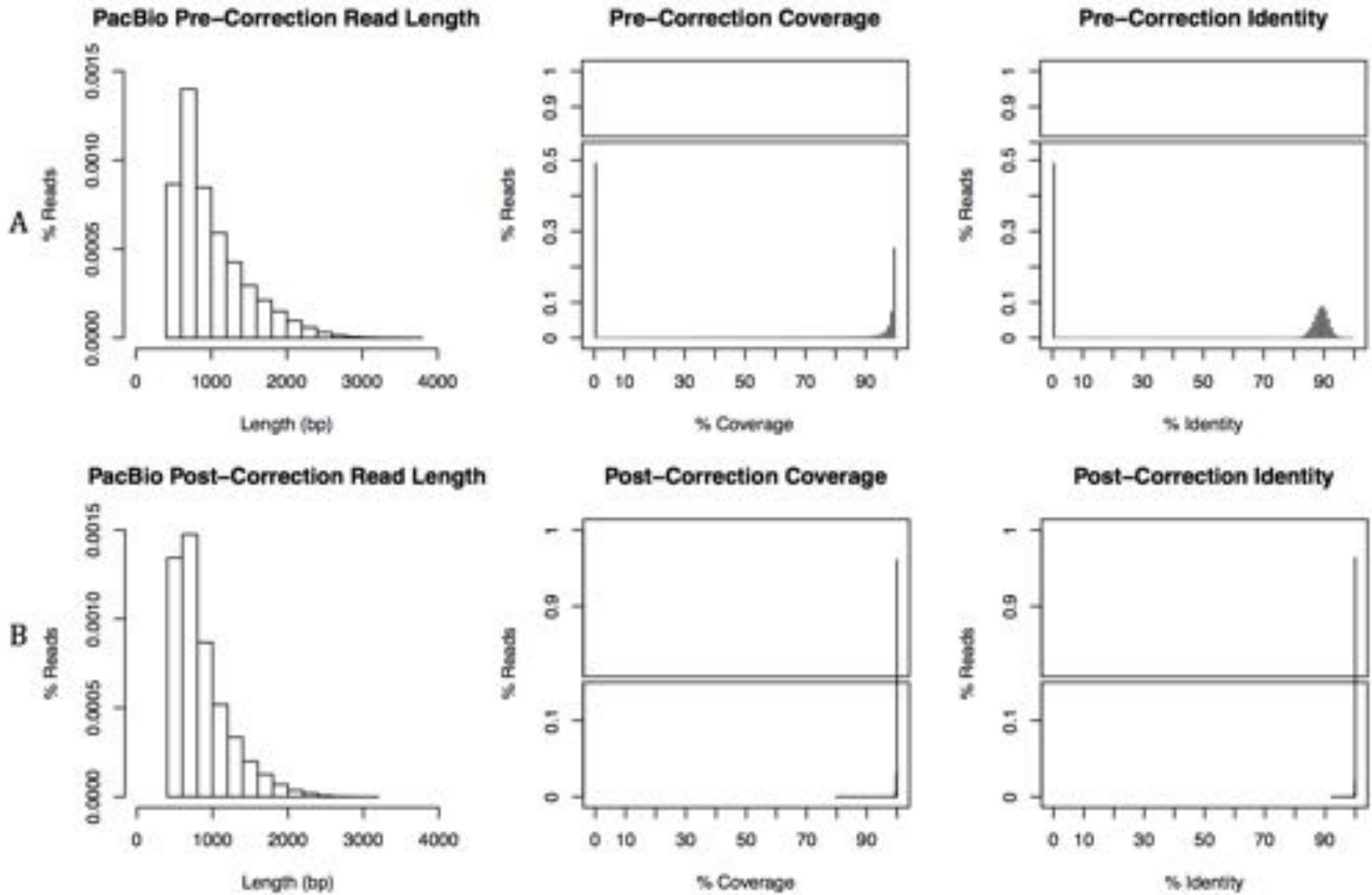

Correction results of 20x PacBio coverage of *E. coli* K12 corrected using 50x Illumina

Celera Assembler

<http://wgs-assembler.sf.net>

1. Pre-overlap
 - Consistency checks
2. Trimming
 - Quality trimming & partial overlaps
3. Compute Overlaps
 - Find high quality overlaps
4. Error Correction
 - Evaluate difference in context of overlapping reads
5. Unitigging
 - Merge consistent reads
6. Scaffolding
 - Bundle mates, Order & Orient
7. Finalize Data
 - Build final consensus sequences

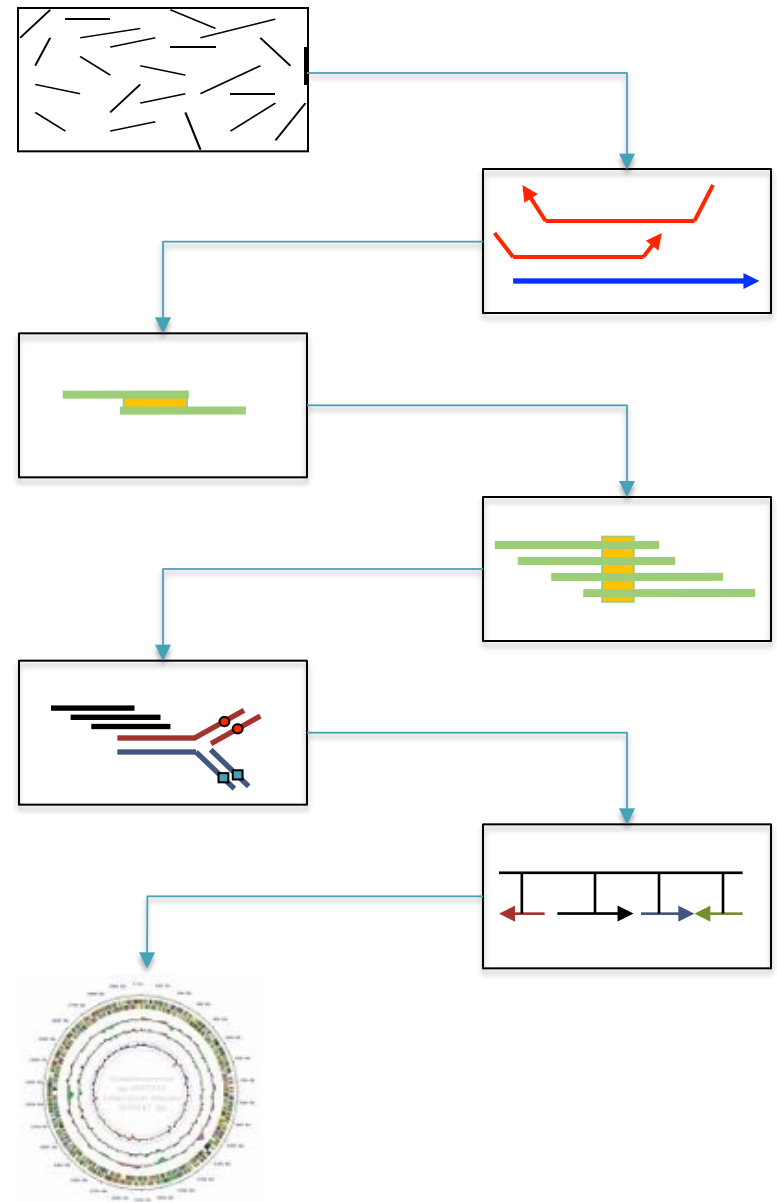

SMRT-Assembly Results

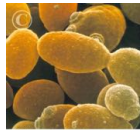

Organism	Technology	Reference bp	Assembly bp	# Contigs	Max Contig Length	N50
<i>Lambda</i> NEB3011 (median: 727 max: 3 280)	Illumina 100X 200bp	48 502	48 492	1	48 492 / 48 492	48 492 / 48 492 (100%) *
	PacBio PBcR 25X		48 440	1	48 444 / 48 444	48 444 / 48 440 (100%) *
<i>E. coli</i> K12 (median: 747 max: 3 068)	Illumina 100X 500bp	4 639 675	4 462 836	61	221 615 / 221 553	100 338 / 83 037 (82.36%) *
	PacBio PBcR 18X		4 465 533	77	239 058 / 238 224	71 479 / 68 309 (95.57%) *
	Both 18X PacBio PBcR + Illumina 50X 500bp		4 576 046	65	238 272 / 238 224	93 048 / 89 431 (96.11%) *
<i>E. coli</i> C227-11 (median: 1 217 max: 14 901)	PacBio CCS 50X	5 504 407	4 917 717	76	249 515	100 322
	PacBio 25X PBcR (corrected by 25X CCS)		5 207 946	80	357 234	98 774
	Both PacBio PBcR 25X + CCS 25X		5 269 158	39	647 362	227 302
	PacBio 50X PBcR (corrected by 50X CCS)		5 445 466	35	1 076 027	376 443
	Both PacBio PBcR 50X + CCS 25X		5 453 458	33	1 167 060	527 198
	Manually Corrected ALLORA Assembly ⁸		5 452 251	23	653 382	402 041
<i>S. cerevisiae</i> S228c (median: 674 max: 5 994)	Illumina 100X 300bp	12 157 105	11 034 156	192	266 528 / 227 714	73 871 / 49 254 (66.68%) *
	PacBio PBcR 13X		11 110 420	224	224 478 / 217 704	62 898 / 54 633 (86.86%) *
	Both PacBio PBcR 13X + Illumina 50X 300bp		11 286 932	177	262 846 / 260 794	82 543 / 59 792 (72.44%) *
<i>Melospiza ardens</i> (median 997, max 13 079)	Illumina 194X (220/500/800 paired-end 2/5/10Kb mate-pairs)	1.23 Gbp	1 023 532 850	24 181	1 050 202	47 383
	454 15.4X (FLX + FLX Plus + 3/8/20Kbp paired-ends)		999 168 029	16 574	751 729	75 178
	454 15.4X + PacBio PBcR 3.75X		1 071 356 415	15 081	1 238 843	99 573

Hybrid assembly results using error corrected PacBio reads
 Meets or beats Illumina-only or 454-only assembly in every case
***** Also useful for transcriptome, repeat, and other analysis *****

The rise of mega-genomics

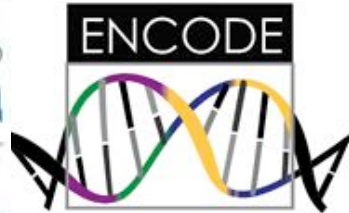

De novo Assembly

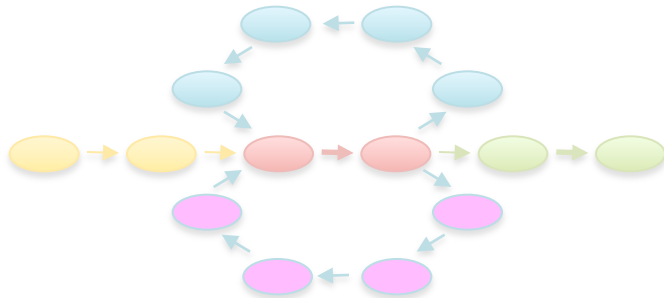

Alignment & Variations

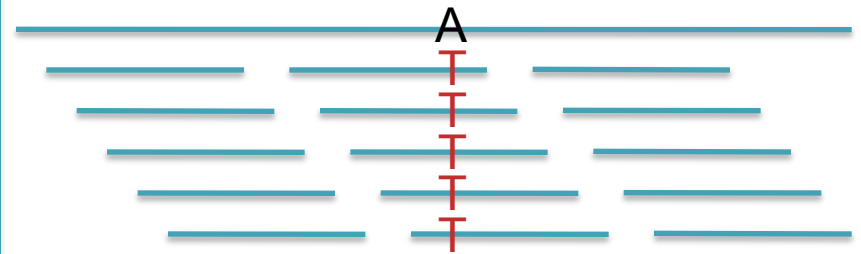

Differential Analysis



Phylogeny, Evolution, and Modeling

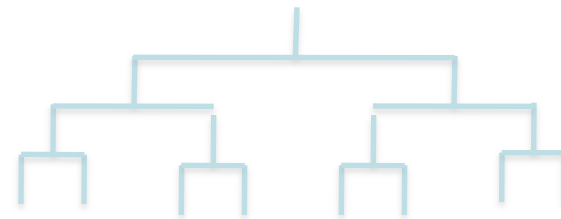

Short Read Mapping

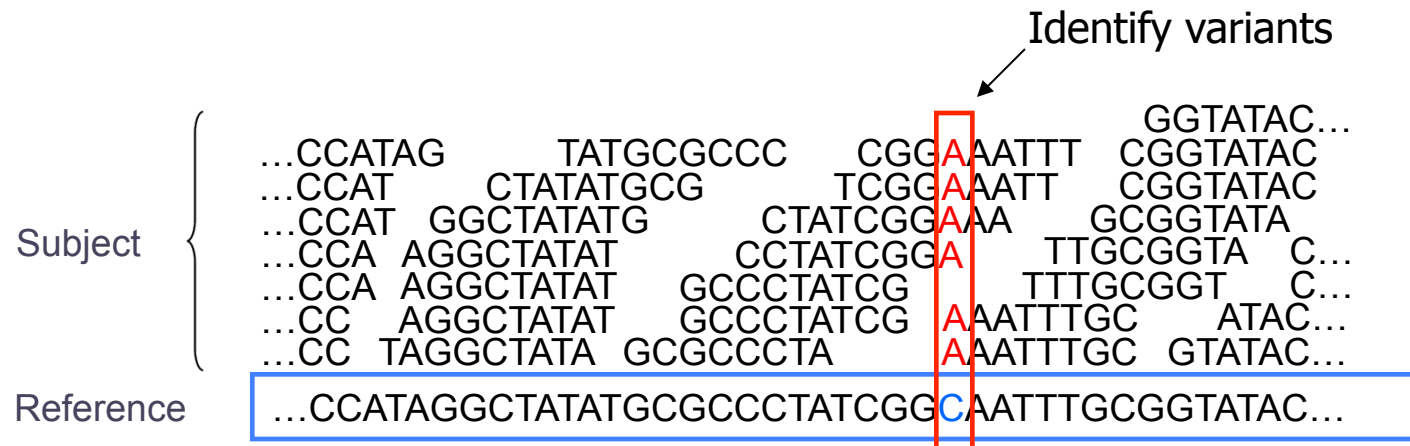

- Given a reference and many subject reads, report one or more “good” end-to-end alignments per alignable read
 - Find where the read most likely originated
 - Fundamental computation for many assays
 - Genotyping RNA-Seq Methyl-Seq
 - Structural Variations Chip-Seq Hi-C-Seq

- Desperate need for scalable solutions
 - Single human requires >1,000 CPU hours / genome

DNA Data Tsunami

Current world-wide sequencing capacity exceeds 14Pbp/year and is growing at 5x per year!

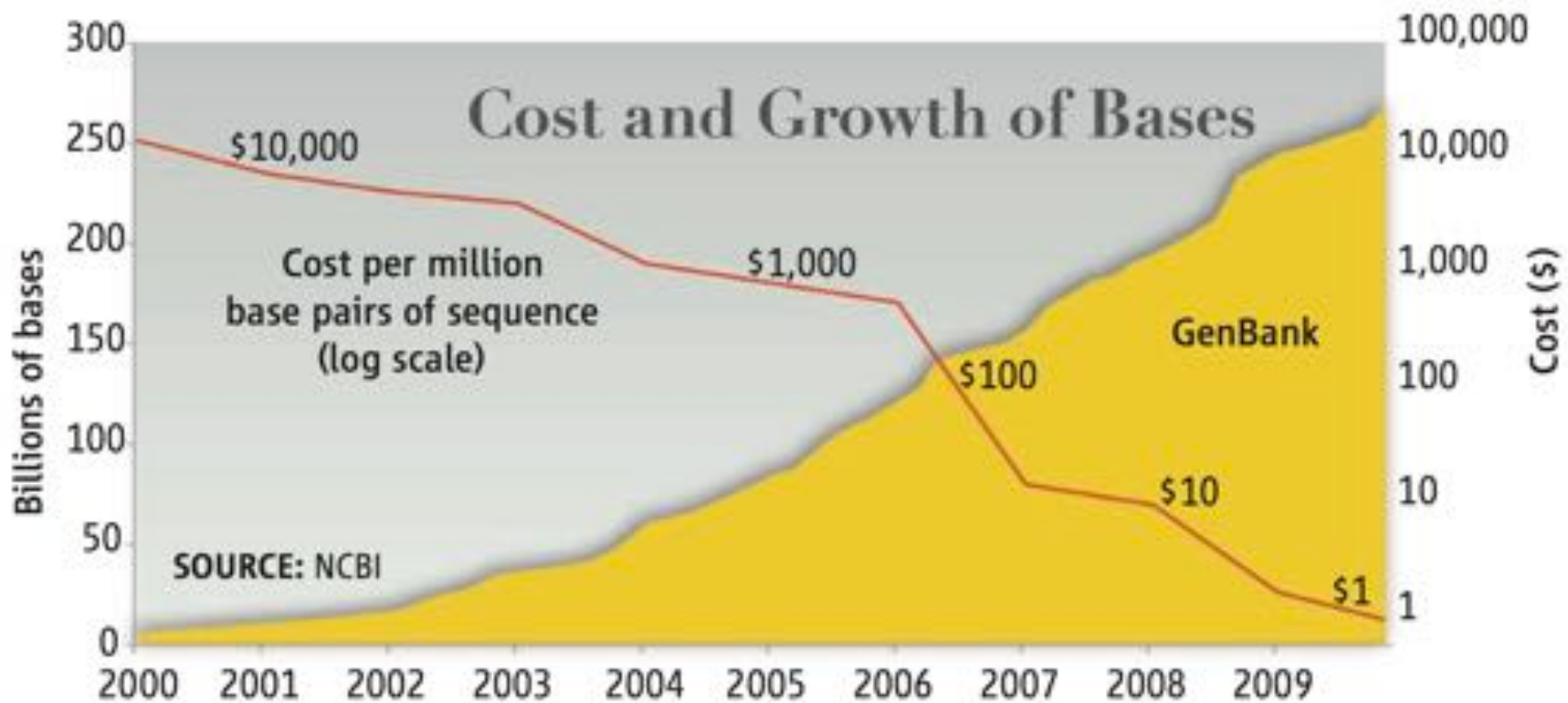

"Will Computers Crash Genomics?"

Elizabeth Pennisi (2011) *Science*. 331(6018): 666-668.

Hadoop MapReduce

<http://hadoop.apache.org>

- MapReduce is Google's framework for large data computations
 - Data and computations are spread over thousands of computers
 - Indexing the Internet, PageRank, Machine Learning, etc... (Dean and Ghemawat, 2004)
 - 946PB processed in May 2010 (Jeff Dean at Stanford, 11.10.2010)
 - Hadoop is the leading open source implementation
 - Developed and used by Yahoo, Facebook, Twitter, Amazon, etc
 - GATK is an alternative implementation specifically for NGS
- Benefits
 - Scalable, Efficient, Reliable
 - Easy to Program
 - Runs on commodity computers
- Challenges
 - Redesigning / Retooling applications
 - Not Condor, Not MPI
 - Everything in MapReduce



System Architecture

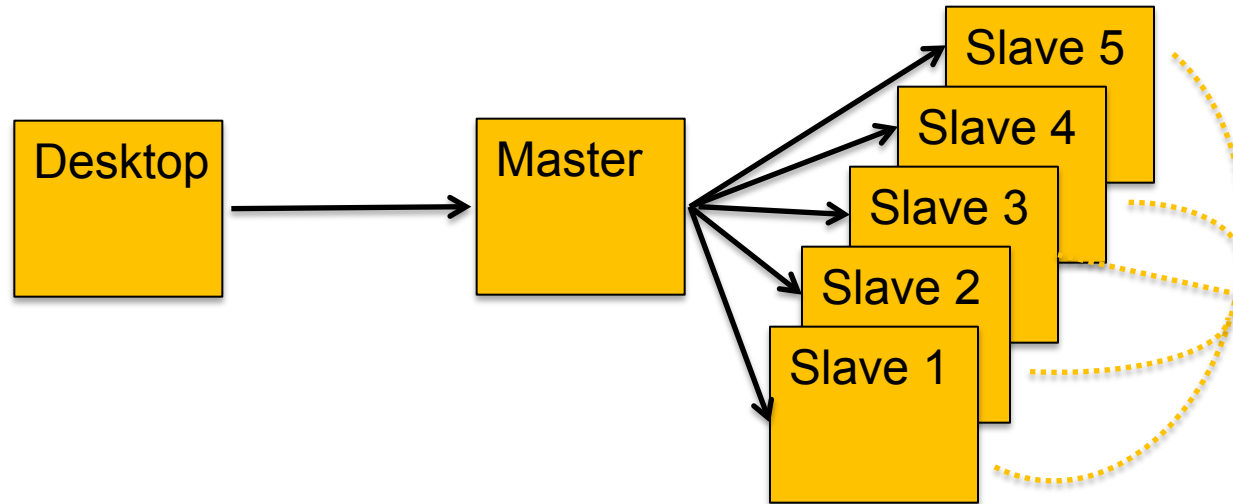

- Hadoop Distributed File System (HDFS)
 - Data files partitioned into large chunks (64MB), replicated on multiple nodes
 - Computation moves to the data, rack-aware scheduling
- Hadoop MapReduce system won the 2009 GreySort Challenge
 - Sorted 100 TB in 173 min (578 GB/min) using 3452 nodes and 4x3452 disks

Hadoop for NGS Analysis



CloudBurst

Highly Sensitive Short Read Mapping with MapReduce

100x speedup mapping on 96 cores @ Amazon

<http://cloudburst-bio.sf.net>

(Schatz, 2009)

Myrna

Cloud-scale differential gene expression for RNA-seq

Expression of 1.1 billion RNA-Seq reads in ~2 hours for ~\$66

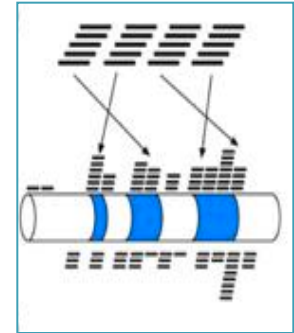

(Langmead, Hansen, Leek, 2010)

<http://bowtie-bio.sf.net/myrna/>

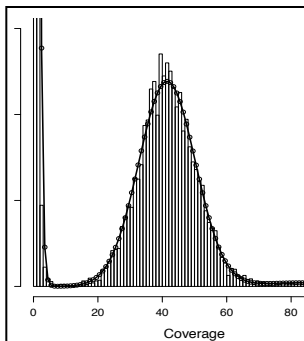

Quake

Quality-aware error correction of short reads

Correct 97.9% of errors with 99.9% accuracy

<http://www.cbcb.umd.edu/software/quake/>

(Kelley, Schatz, Salzberg, 2010)

Genome Indexing

Rapid Parallel Construction of Genome Index

Construct the BWT of the human genome in 9 minutes

```
$GATTACA  
A$GATTAC  
ACA$GATT  
ATTACA$G  
CA$GATTA  
GATTACA£  
TACA$GAT  
TTACA$GA
```

(Menon, Bhat, Schatz, 2011)

<http://code.google.com/p/genome-indexing/>



Crossbow

<http://bowtie-bio.sourceforge.net/crossbow>

- Align billions of reads and find SNPs
 - Reuse software components: Hadoop Streaming
- Map: Bowtie (Langmead *et al.*, 2009)
 - Find best alignment for each read
 - Emit (chromosome region, alignment)
- Shuffle: Hadoop
 - Group and sort alignments by region
- Reduce: SOAPsnp (Li *et al.*, 2009)
 - Scan alignments for divergent columns
 - Accounts for sequencing error, known SNPs

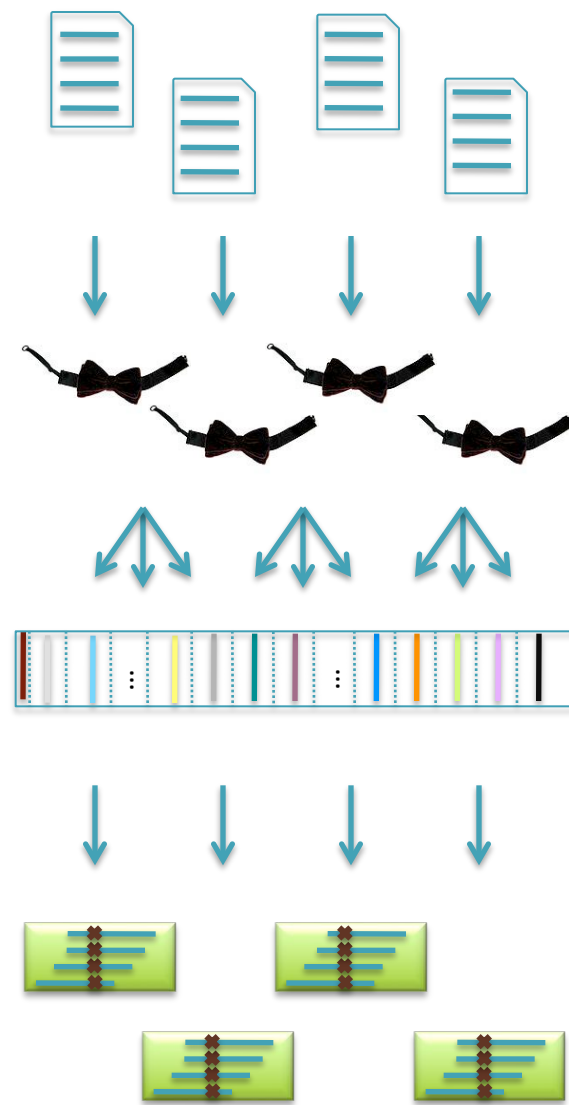

Performance in Amazon EC2

<http://bowtie-bio.sourceforge.net/crossbow>

	Asian Individual Genome		
Data Loading	3.3 B reads	106.5 GB	\$10.65
Data Transfer	1h :15m	40 cores	\$3.40
Setup	0h : 15m	320 cores	\$13.94
Alignment	1h : 30m	320 cores	\$41.82
Variant Calling	1h : 00m	320 cores	\$27.88
End-to-end	4h : 00m		\$97.69

Discovered 3.7M SNPs in one human genome for ~\$100 in an afternoon.
Accuracy validated at >99%

Searching for SNPs with Cloud Computing.

Langmead B, Schatz MC, Lin J, Pop M, Salzberg SL (2009) *Genome Biology*. **10**:R134

Map-Shuffle-Scan for Genomics

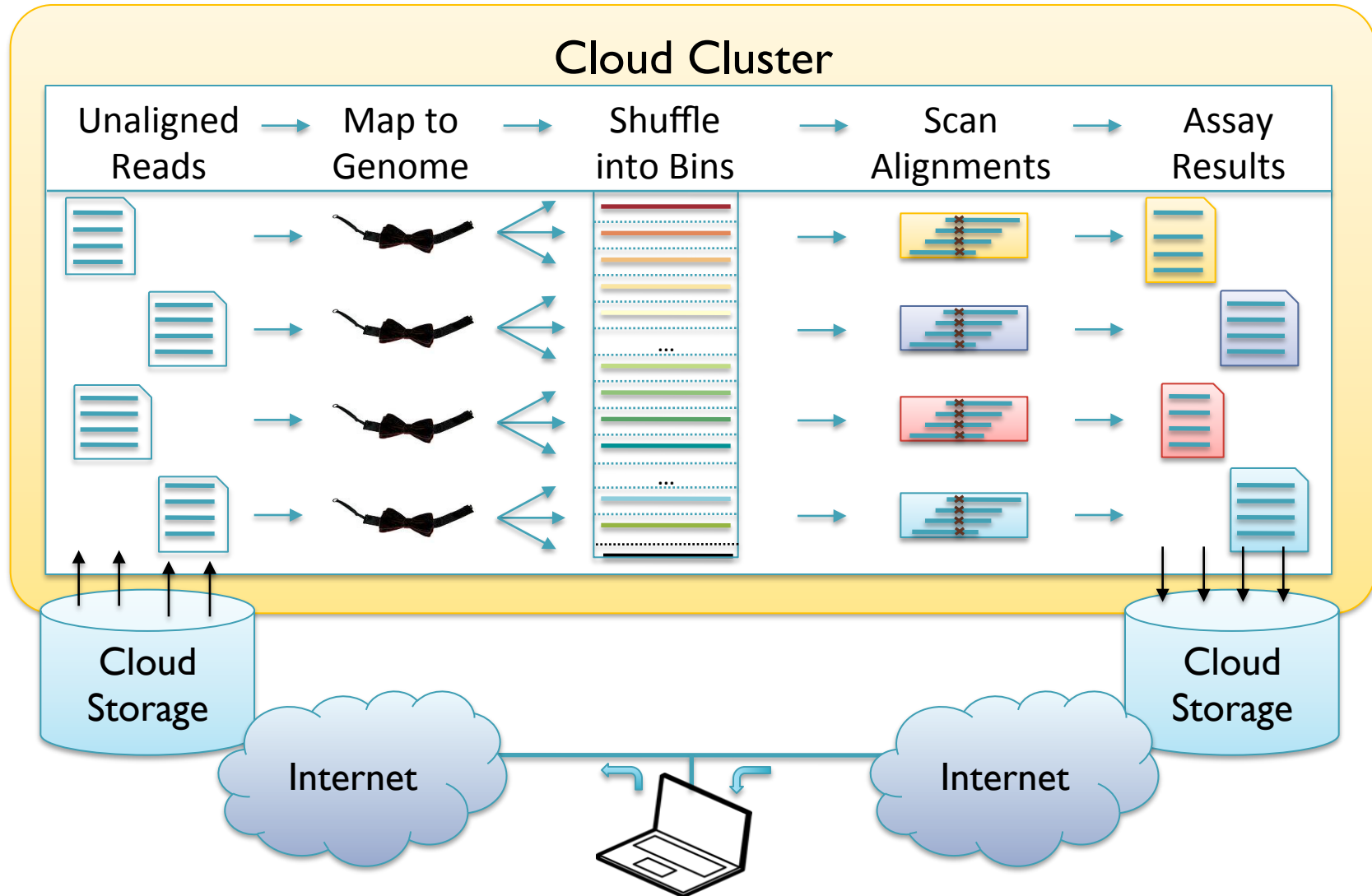

Cloud Computing and the DNA Data Race.

Schatz, MC, Langmead B, Salzberg SL (2010) *Nature Biotechnology*. **28**:691-693

Jnomics: Cloud-scale genomics

Matt Titmus, James Gurtowski, Michael Schatz

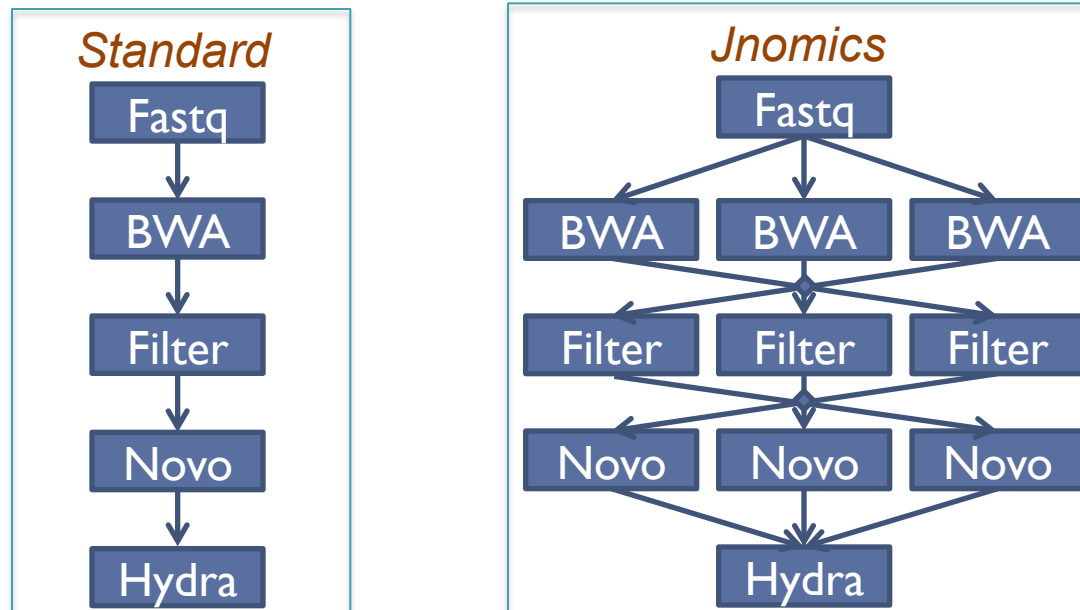

- Rapid parallel execution of NGS analysis pipelines
 - FASTX, BWA, Bowtie, Novoalign, SAMTools, Hydra
 - Sorting, merging, filtering, selection, of BAM, SAM, BED, fastq
 - Population analysis: Clustering, GWAS, Trait Inference

Answering the demands of digital genomics

Titmus, M.A., Schatz, M.C.. (2012) *Under Review*

Jnomics Structural Variations

Sample Separation: 2kbp

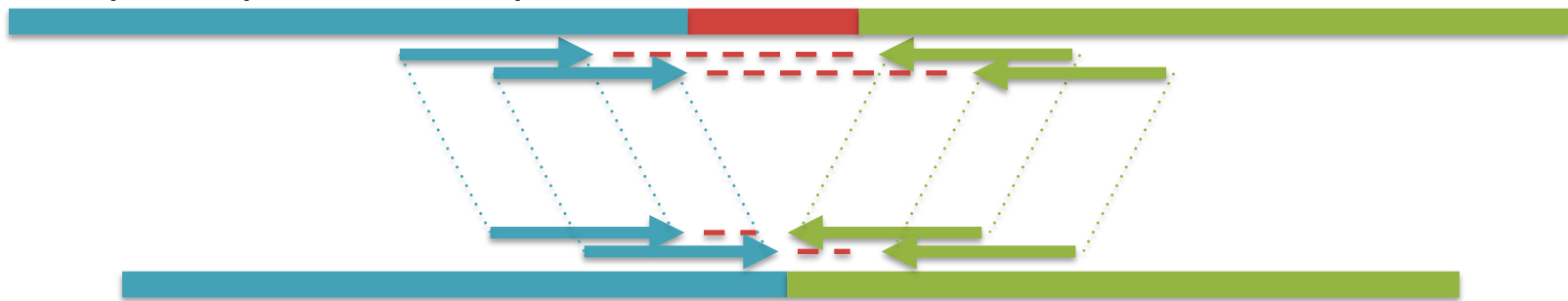

Mapped Separation: 1kbp

Discordant Pair Analysis

- Identify clusters of pairs too close or too far away indicating a SV

Circos plot of high confidence SVs specific to esophageal cancer sample

- Red: SVs specific to tumor
- Green: SVs in both diseased and tumor samples

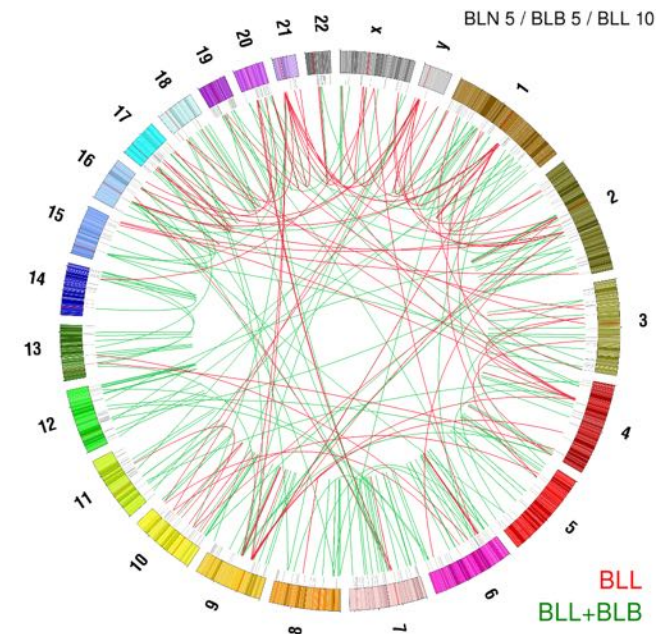

The rise of mega-genomics

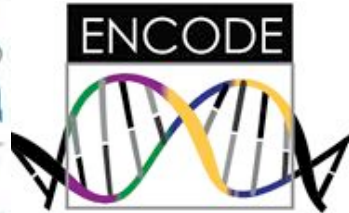

De novo Assembly

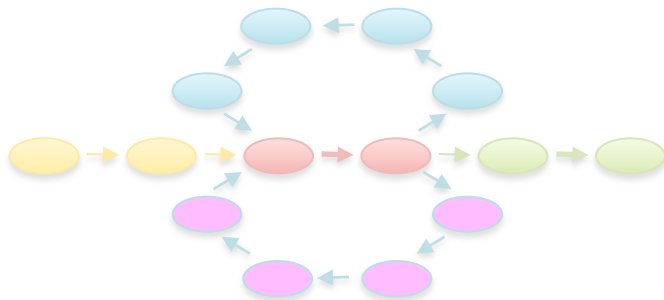

Alignment & Variations

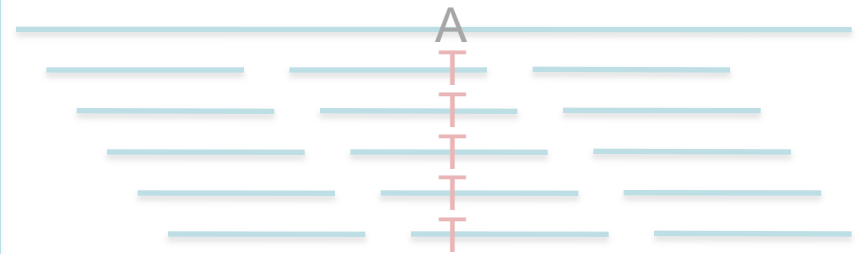

Differential Analysis



Phylogeny, Evolution, and Modeling

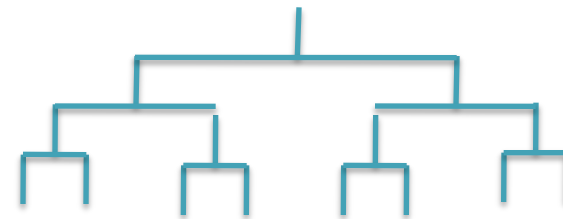

Unified Model of Autism

Sporadic Autism

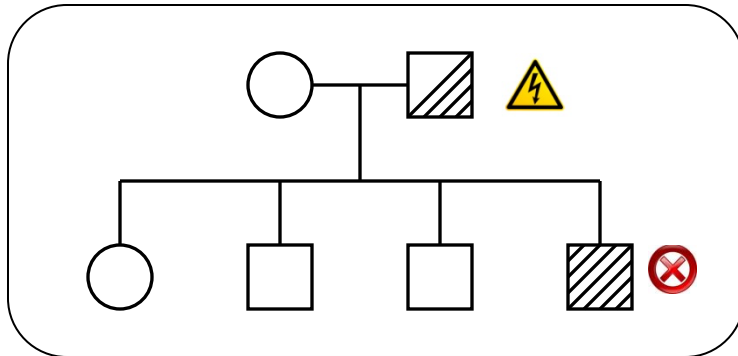

De novo mutations of high penetrance contributes to autism, especially in families with lower risk than in families at higher risk.

Familial Autism

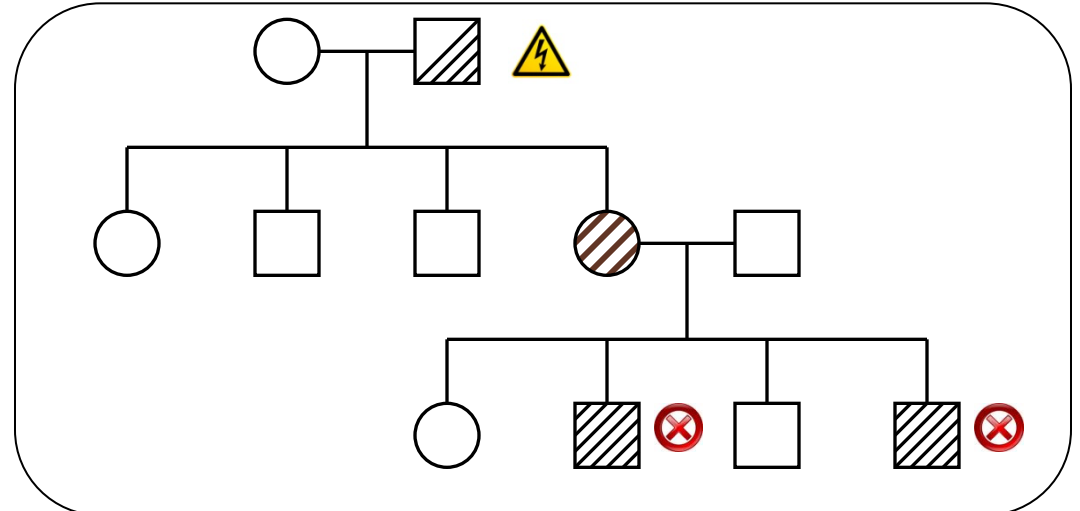

Legend



Sporadic mutation



Fails to procreate

A unified genetic theory for sporadic and inherited autism

Zhao *et al.* (2007) *PNAS*. 104(31)12831-12836.

Autism and de novo CNVs

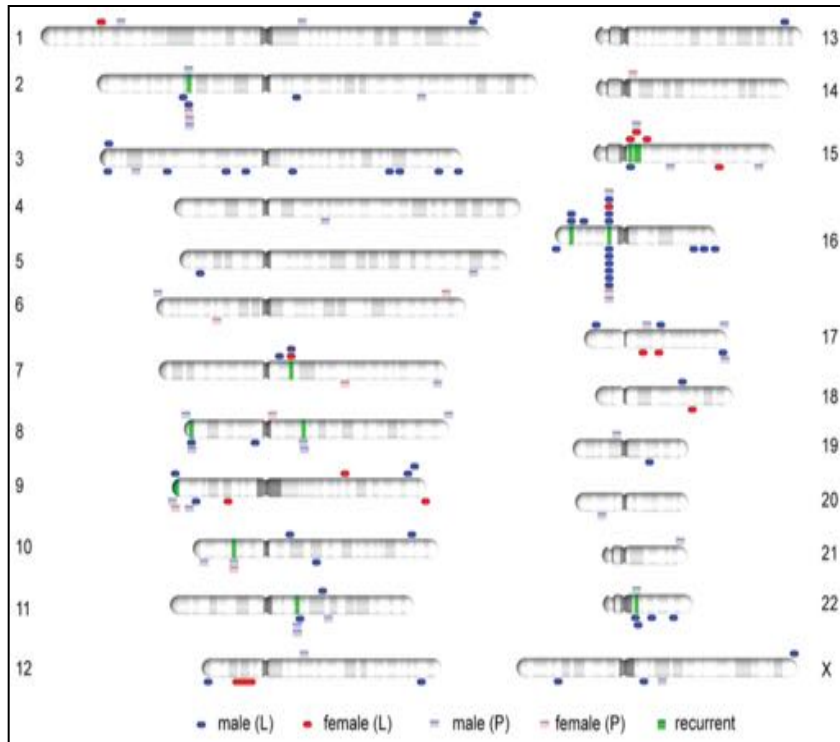

Analysis of Simons Simplex Collection

- CGH arrays of 510 family quads
- 94 total de novo CNVs discovered

De novo CNVs are more common in autistic children

- 4:1 ratio in autistic kids relative to their non-autistic siblings
- Some recurrence at genes related to other psychiatric conditions

	Counts of De Novo Events			Children with De Novo Events			Frequency in Children		
	Combined	Del	Dup	Combined	Del	Dup	Combined	Del	Dup
aut	75	46	29	68	44	27	7.9%	5.1%	3.1%
sib	19	9	10	17	8	9	2.0%	0.9%	1.0%

Rare de novo and transmitted copy-number variation in autism spectrum disorders.
 Levy et al. (2011) *Neuron*. 70:886-897.

Exome Sequencing Pipeline

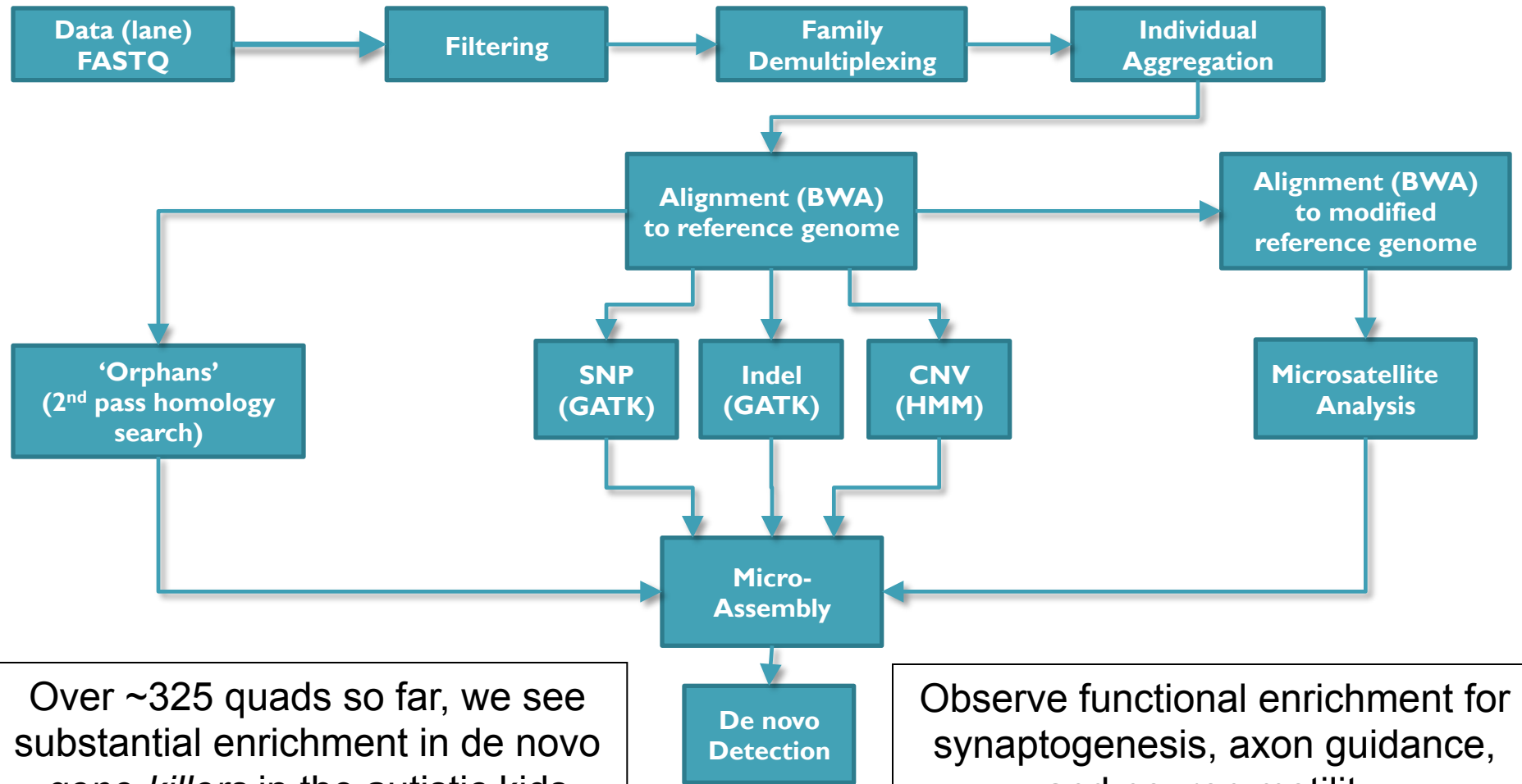

Assessing the role of de novo gene-killers in the incidence of autism

Iossifov et al. (2012) In preparation

Scalpel: Haplotype Microassembly

G. Narzisi, D. Levy, I. Iossifov, J. Kendall, M. Wigler, M. Schatz



- Use assembly techniques to identify complex variations from short reads
 - Improved power to find indels
 - Trace candidate haplotypes sequences as paths through assembly graphs



Ref: ...TCAGAACAGCTGGATGAGATCTTAGCCAACTACCAGGAGATTGTCTTTGCCCGGA...

Father: ...TCAGAACAGCTGGATGAGATCTTAGCCAACTACCAGGAGATTGTCTTTGCCCGGA...

Mother: ...TCAGAACAGCTGGATGAGATCTTAGCCAACTACCAGGAGATTGTCTTTGCCCGGA...

Sib: ...TCAGAACAGCTGGATGAGATCTTAGCCAACTACCAGGAGATTGTCTTTGCCCGGA...

Aut(1): ...TCAGAACAGCTGGATGAGATCTTAGCCAACTACCAGGAGATTGTCTTTGCCCGGA...

Aut(2): ...TCAGAACAGCTGGATGAGATCTTACC-----CCGGGAGATTGTCTTTGCCCGGA...

6bp heterozygous indel at chr13:25280526 ATP12A

The rise of mega-genomics

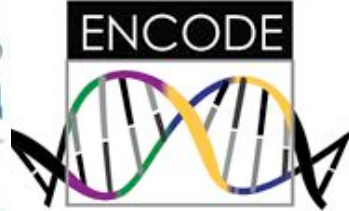

De novo Assembly

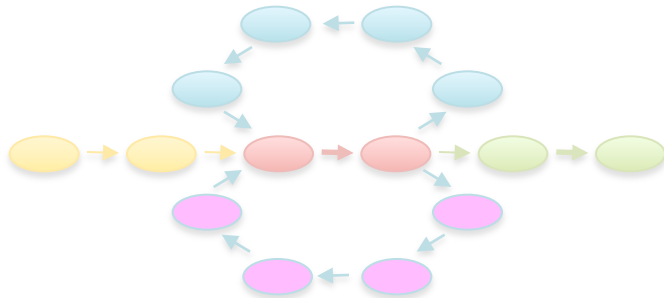

Alignment & Variations

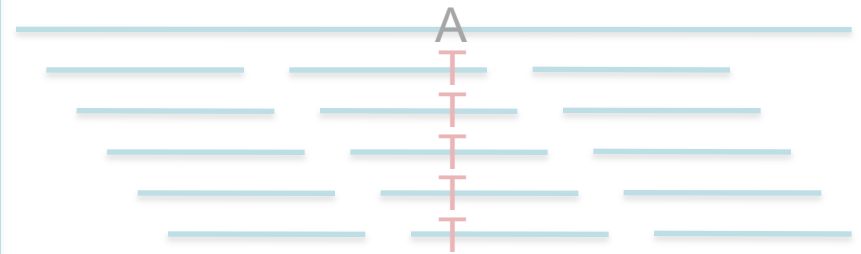

Differential Analysis



Phylogeny, Evolution, and Modeling

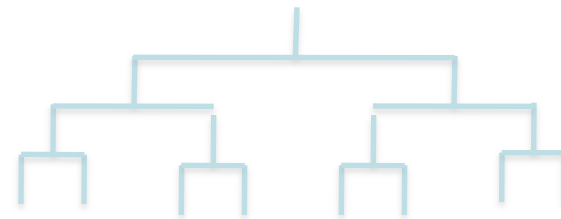

Summary

I'm focused on the intersection of the most significant biology, biotechnology, and compute technology

We are entering the era of mega-genomics

- Explosion in digital traits and measurements
- Parallel systems essential for analyzing large data sets
- Algorithms and machine learning to squeeze insight out of diverse data types
- Collaborations with biologists and visual informatics systems to help execute experiments & interpret results

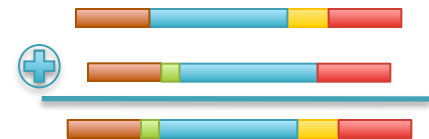
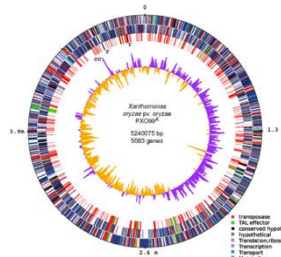

Acknowledgements



Giuseppe Narzisi
Mitch Bekritsky

Ivan Iossifov
Wigler Lab

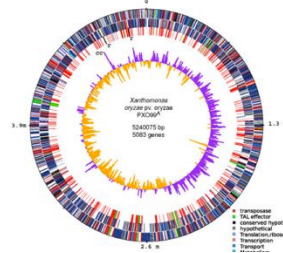

Hayan Lee
Matt Titmus
James Gurtowski

Ware Lab
McCombie Lab

Adam Phillippy (NBACC)
Sergey Koren (NBACC)

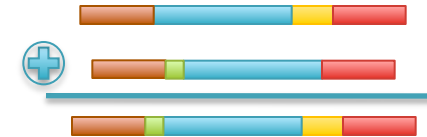

Paul Baranay (CSHL/ND)

Scott Emrich (ND)
Steven Salzberg (JHU)
Mihai Pop (UMD)



Thank You!

<http://schatzlab.cshl.edu/apply>
[@mike_schatz](#)

